



# MERCURA<sup>®</sup>

ALUMINIUM MOBILE SOLUTIONS



OSAKA  
ONTARIO



## Osaka



Osaka Mono 60L  
Ref. 1 181 011



Osaka Mono 110L  
Ref. 1 181 013

Mobile sack holder for any kind of bag for selective collection of soiled linen and waste.

### FEATURES

- Completely in anodised aluminium
- Base platform in anodised aluminium
- 4 swivel wheels Ø 75 mm with circular buffer
- Exists in 4 versions : mono, double, triple or quadruple
- Exists in 3 sizes : 50L, 60L or 110 L
- Bags not included

### OPTIONS :

- Lids operated with or without pedals
- Large selection of polyester and plastic bags
- Silent wheels
- Brake(s)



► Holder ring in stainless steel instead of rubber for total hygiene. The heavier the load, the better it holds.



Osaka Triple 110L  
Ref. 1 181 045



Osaka Double 60L  
Ref. 1 181 032



Osaka Triple 60L  
Ref. 1 181 043



► Double pedal system : large pedal to open lid and to keep it open; small pedal to release lid.



► Silent wheels



Osaka Quadruple 60L  
Ref. 1 181 051



► Wheel with brake

**SPECIAL FINISHINGS - examples**



► Double Osaka covered with ceruse oak panelling.







► Osaka completely closed with panels and lid in anodised aluminium.



► Quadruple Osaka; 1 sack holder was replaced by a small cabinet for clean linen.



## Osaka

OSAKA	TYPE	OVERALL SIZE L X W* X H	WHEELS Ø MM	CODE	LID	LIDS & PEDALS*
<b>MONO</b> 	Mono 50 L	350 x 475* x 870	75	1 181 010	1 181 020	1 181 030
	Mono 60 L	400 x 530* x 870	75	1 181 011	1 181 021	1 181 031
	Mono 110 L	500 x 530* x 870	75	1 181 013	1 181 023	1 181 033
<b>DOUBLE</b> 	Double 60 L	700 x 530* x 870	75	1 181 012	1 181 022	1 181 032
	Double 110 L	900 x 530* x 870	75	1 181 067	1 181 068	1 181 069
<b>TRIPLE</b> 	Triple 60 L	1000 x 530* x 870	75	1 181 041	1 181 042	1 181 043
	Triple 110 L	1300 x 530* x 870	75	1 181 045	1 181 046	1 181 047
<b>QUADRUPLE</b> 	Quadruple 60 L	700 x 1025* x 870	75	1 181 051	1 181 052	1 181 053
	Quadruple 110 L	900 x 1025* x 870	75	1 181 059	1 181 060	1 181 061
<b>Option</b>	Locking pedal					1 181 103

\* Overall dimension shown for trolleys without pedals. Please add 20 mm extra width for pedals.

## LINEN BAGS IN POLYESTER

► Striped bags in washable polyester, with nylon string and fix-lock system.



COLOUR	60 L	120 L
Blue-white	1 158 811	1 158 821
Yellow-white	1 158 812	1 158 822
Green-white	1 158 813	1 158 823
Red-white	1 158 814	1 158 824



# Ontario Murano

## Wall sack holder

### FEATURES

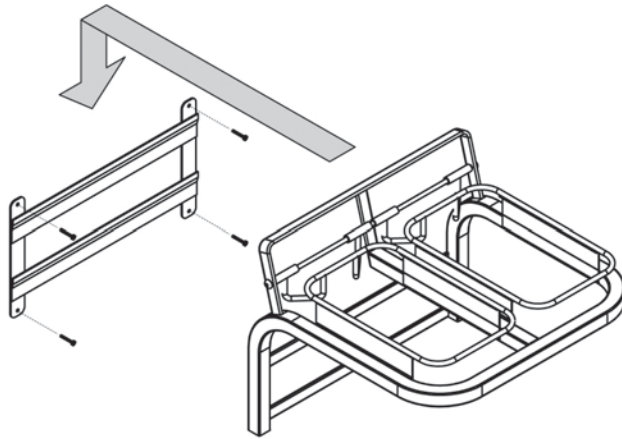
- Completely in anodised aluminium, welded frame
- Exists in 3 versions : mono 60L or 110L, or double 50L
- Bags not included
- Lid optional



ONTARIO MURANO	TYPE	OVERALL SIZE L X W X H	CODE	LID
<b>MONO</b>	 Mono 60 L	370 x 425 x 355	1 180 410	1 180 411
	 Mono 110 L	460 x 425 x 355	1 180 420	1 180 421
<b>DUPLI</b>	 Dupli 50 L	460 x 425 x 355	1 180 423	1 180 424 *

\* Common lid for both sacks

## BAGS IN POLYETHYLENE

► Bags in polyethylene with gusset

COLOUR	60 L	120 L
Blue	1 158 701	1 158 703
Yellow	1 158 702	1 158 704

Minimal quantity of 500 pieces

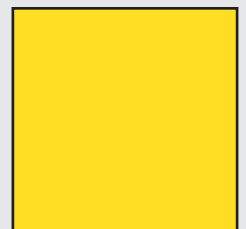
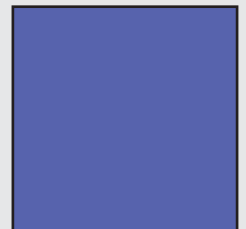
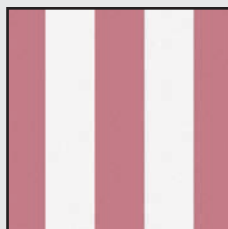
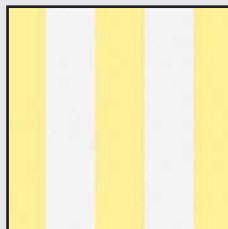



Mercura Industries s.a./n.v.  
Rue Bois des Îles 15  
Eilandenhoutstraat 15  
B-1082 Brussels

Tel: +32 (0)2 482 11 30  
Fax: +32 (0)2 468 18 48

[www.mercura.com](http://www.mercura.com)  
[info@mercura.com](mailto:info@mercura.com)

© 2006, Mercura Industries